



iPANEL 2

iPANEL 2 offre la migliore soluzione per progetti che richiedono una grande quantità di scene con un'interfaccia non ingombrante e intuitiva. iPANEL 2, programmabile da computer, è in grado di eseguire fino a 99 scene, ciascuna delle quali possono essere modificate premendo il pulsante MODE per cambiare il livello dimmer e il colore.

SPECIFICHE TECNICHE

- Controller DMX Stand Alone a 512ch con un frontalino in vetro
- 4 pulsanti Touch Sensitive
- Scene dinamiche create come successione di passi di durata regolabile
- Regolazione, durante l'esecuzione, della luminosità e del colore di una scena
- Ampia capacità di memoria
- Fino a 99 scene
- Programmabile con cavo USB e software di controllo in dotazione
- Morsetteria a 5 pin nella parte posteriore: 3 x DMX, 2 x alimentazione
- 512 Canali DMX
- Pronto per l'uso (precaricato)
- Utilizzabile via USB con PC, Mac e Tablet
- Tecnologia ARM a 32 bit
- Alimentatore 5-12V AC / DC (opzionale).

iPANEL 2 offers the best solution for projects requiring a large amount of scenes along with an uncluttered and intuitive interface. The computer programmable iPANEL 2 is capable of playing up to 99 scenes, each of which can be modified by touching the MODE button to change the dimmer and color.

TECHNICAL SPECIFICATIONS

- DMX512 Stand Alone Controller with a glass face
- 4 touch sensitive buttons
- Dynamic scenes created step by step with adjustable timing
- Live setting of the intensity and color of a scene
- Large memory capacity
- Up to 99 scenes
- Programmable with the included USB cable and control software
- 5 pin -connector block at the rear : 3 pin DMX, 2 pin power
- 512 DMX channels
- Ready to use (pre-loaded)
- For PC, Mac & Tablet with USB32bit ARM
- 32bit ARM technology
- Works with 5-12V AC/DC adapter (optional).



iPANEL 2



FASE 1/STEP 1

Programmazione e settaggio preliminare dell'impianto
Programming and preliminary set up of the system

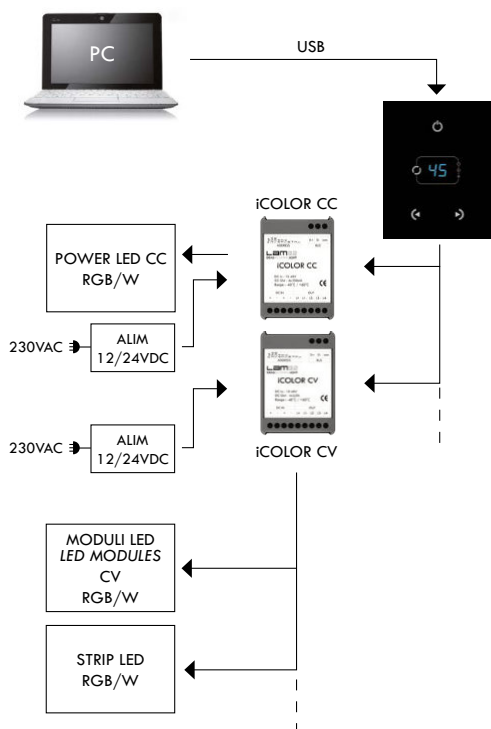

FASE 2/STEP 2

Impianto a regime e perfettamente funzionante
Full performance and functioning of the system

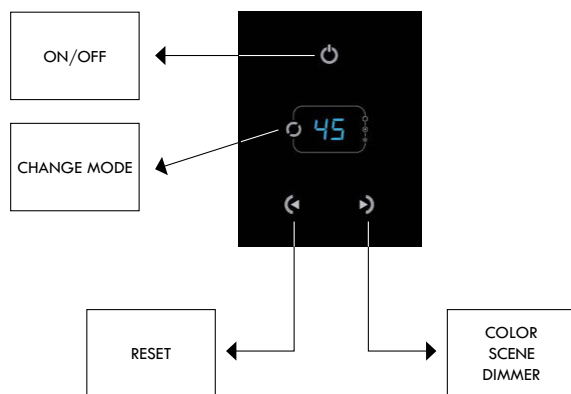
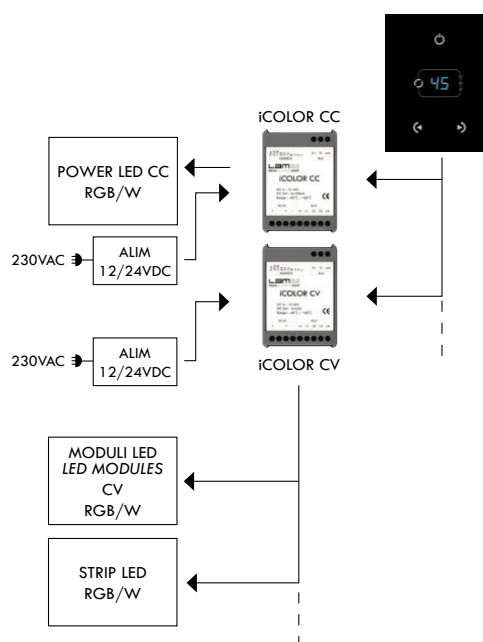

DISEGNO TECNICO/TECHNICAL DRAWING

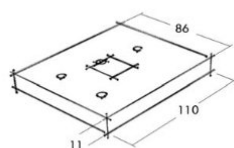

86mm x 11mm x H110mm

iPANEL 2

codice/code

09.100409

FINITURA/FINISH

colore/colour codice/code

 .02 / nero-black

 .01 / bianco-white

ESEMPIO COMPOSIZIONE CODICE
EXAMPLE OF CODE COMPOSITION

09.100409.01

CODICE
CODE

FINITURA
FINISH



LETTURA DELLA SCHEDA READING THE DATA SHEET

NOME FAMIGLIA
SERIES NAME

MARCHI E REQUISITI
MARKING AND REQUIREMENTS

DISEGNO TECNICO
TECHNICAL DRAWING



BIN



DISEGNO TECNICO/TECHNICAL DRAWING

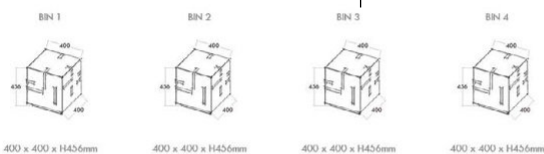

BIN LED	codice/code	sorgente /lamp	lumen /lumens
BIN 1 LUCE/LIGHT	05.101.227	LED 20,5W	2237 2350
BIN 2 LUCE-AUDIO / LIGHT-AUDIO	05.101.228	LED 20,5W	2237 2350
BIN 3 LUCE-WIFI / LIGHT-WIFI	05.101.229	LED 20,5W	2237 2350
BIN 4 LUCE-AUDIO-WIFI / LIGHT-AUDIO-WIFI	05.101.230	LED 20,5W	2237 2350

FINITURA/FINISH

colore/colour	codice/code
	.05 / inox satinato with stainless
	.04 / verniciato cor-ten painted cor-ten
	.03 / verniciato grigio painted grey
	.02 / verniciato nero painted black
	.01 / verniciato bianco painted white

ACCESSORI/ACCESSORIES

PIASTRA TIRAFONDI/ANCHOR PLATE

codice/code	
20.100379	370mm x 370mm H130mm

ESEMPIO COMPOSIZIONE CODICE / EXAMPLE OF CODE COMPOSITION

Alimentatore elettronico 220/240V 30-60Hz integrato nel corpo dell'apparecchio. Electronic driver 220/240V 30-60Hz integrated in the luminaire's body.

05.101.227.01.BP	Colore LED/LED Colour
BP	3000K
RF	4000K

DESCRIZIONE TECNICA DELL'APPARECCHIO
LUMINAIRE TECHNICAL DESCRIPTION

.08/cemento	.08/concrete
.06/alluminio lucido o inox lucido	.06/polished aluminium or polished stainless
.05/alluminio satinato o inox satinato	.05/satin aluminium or satin stainless
.04/verniciato cor-ten	.04/painted cor-ten
.03/verniciato grigio (RAL 9006) o alluminio anodizzato	.03/painted grey (RAL 9006) or anodized aluminium
.02/verniciato nero (RAL 9005) o anodizzato nero	.02/painted black (RAL 9005) or black anodized
.01/verniciato bianco (RAL 9016)	.01/painted white (RAL 9016)
.00/naturale	.00/natural

FINITURE DISPONIBILI
AVAILABLE FINISHES















TABELLA COMPOSIZIONE CODICE
CODE COMPOSITION TABLE

DESCRIZIONE SORGENTE
LAMP DESCRIPTION

CODICE RADICE APPARECCHIO
LUMINAIRE CODE

SIMBOLOGIA SYMBOLS

Configurazioni disponibili/Available configurations

	Apparecchio disponibile in versione RGB (solo per versioni con min. 3 lampade o versioni LED).	Luminaire available in RGB version (only for versions with a min. of 3 lamps or LED versions).
	Apparecchio disponibile in versione CTC (controllo temperatura di colore, solo per versioni con min. 3 lampade o versioni LED).	Luminaire available in CTC version (colour temperature control, only for versions with a min. of 3 lamps or LED versions).
	Apparecchio con possibilità di dimmerazione.	Luminaire has possibility to be dimmed.
	Apparecchio con possibilità di dimmerazione 0/10.	Luminaire has possibility to be dimmed 0/10.
	Apparecchio con possibilità di dimmerazione DALI.	Luminaire has possibility to be dimmed DALI.
	Apparecchio con possibilità di dimmerazione PWM.	Luminaire has possibility to be dimmed PWM.
	Apparecchio disponibile con apparato di diffusione sonora ad induzione.	Luminaire available with induction sound diffusion system.
	Apparecchio disponibile con Router Wi-Fi interno per la diffusione nello spazio circostante di segnali wire-less di ogni genere.	Luminaire available with internal Wi-Fi Router for the diffusion of any kind of wireless signal in the surrounding space.
	Kit emergenza	Emergency Kit
	Apparecchio personalizzabile (con fattibilità da verificare). Modifiche su richiesta: -finitura RAL -dimensione -tecnologia di comunicazione (DALI,WIFI o AUDIO integrato)	Luminaire customizable (with feasibility to be checked). Changes on request: -RAL finish -size -communication technology (integrated DALI,WIFI or AUDIO)
	Apparecchio disponibile a richiesta in versione RGB (solo per versioni con sorgente LED o con minimo 3 lampade).	Luminaire available, on request, in RGB version (only for LED versions or with a minimum of 3 lamps).
	Apparecchio disponibile a richiesta in versione CTC (controllo temperatura di colore, solo per versioni con min. 3 lampade o versioni LED).	Luminaire available, on request, in CTC version (colour temperature control, only for versions with a min. of 3 lamps or LED versions).
	Apparecchio disponibile su richiesta in versione dimmerabile.	Luminaire available, on request, in dimmable version.
	Apparecchio disponibile, su richiesta, con schermo microprismatizzato per elevato comfort visivo.	Luminaire available, on request, with microprismatic screen for high visual comfort.
	Protezione Acqua Stop	Water Stop protection

Protezioni IP/IP Protection degree code

1° CIFRA - Protezione da corpi solidi/

IP1...	Protezione da corpi solidi $\geq 50\text{mm}$
IP2...	Protezione da corpi solidi $\geq 12\text{mm}$
IP3...	Protezione da corpi solidi $\geq 2,5\text{mm}$
IP4...	Protezione da corpi solidi $\geq 1\text{mm}$
IP5...	Protezione da polvere
IP6...	Protezione totale da polvere

2° CIFRA - Protezione da acqua

IP..1	Protezione da caduta di gocce verticali
IP..2	Protezione da caduta di gocce con inclinazione di 15°
IP..3	Protezione da spruzzi d'acqua con inclinazione di 60° dall'alto
IP..4	Protezione dagli spruzzi d'acqua da ogni direzione
IP..5	Protezione dai getti d'acqua
IP..6	Protezione da inondazioni
IP..7	Protezione contro l'immersione temporanea fino a $30'$ sotto 1m d'acqua
IP..8	Protezione contro l'immersione continua sotto 1m d'acqua

1st DIGIT - Protection against solid bodies

IP1...	Protection against solid bodies $\geq 50\text{mm}$
IP2...	Protection against solid bodies $\geq 12\text{mm}$
IP3...	Protection against solid bodies $\geq 2,5\text{mm}$
IP4...	Protection against solid bodies $\geq 1\text{mm}$
IP5...	Protection against dust
IP6...	Total protection against dust











2nd DIGIT - Protection against water

IP..1	Protection against vertically falling drops
IP..2	Protection against vertically falling drops with a tilt angle up to 15°
IP..3	Protection against sprays of water up to 60° from devertical
IP..4	Protection against water spray from all directions
IP..5	Protection against water jets
IP..6	Protection against powerful water jets
IP..7	Protection against temporary immersion up to $30'$ under 1m of water
IP..8	Protection against continuous immersion under 1m of water

Tipologia di alimentazione/Power supply type



Marchi e requisiti/Certificates and requirements

	Apparecchio in classe prima con isolamento elettrico fondamentale. Deve essere collegato al circuito di terra dell'impianto elettrico generale.	Class I Luminaire with basic electrical insulation. It must be connected to the earth circuit of the general electrical system.
	Apparecchio in classe seconda con doppio isolamento elettrico. Non necessita di collegamento al circuito di terra dell'impianto elettrico.	Class II luminaire with double electrical insulation. There is no need for connection to the earth circuit of the electrical system.
	Apparecchio in classe terza predisposto per il collegamento a circuiti a bassissima tensione.	Class III luminaire suitable for connection to extra-low voltage circuits.
	Marchatura CE	CE Marking
	L'apparecchio può essere installato su superfici normalmente infiammabili.	The luminaire can be installed on normally flammable surfaces.
		
	ISO 9001	
	Ellissi di Macadam.	Macadam Ellipse.
	Resistenza al carico statico.	Static load resistance.
	Lunghezza del cavo di alimentazione in dotazione.	Length of supplied power cable.
	Uscita cavo di alimentazione L= Laterale P= Posteriore T= Testa	Cable Output L= Side P= Rear T= Head
	Protezione contro sbalzi di tensione	Protection against sudden changes in voltage.
	Protezione contro l'inversione di polarità	Reverse polarity protection.
	Rotazione dell'apparecchio sull'asse verticale.	Luminaire rotation on vertical axis.
	Inclinazione dell'apparecchio sull'asse orizzontale.	Luminaire inclination on horizontal axis.
	Tipo di emissione luminosa.	Type of light emission.

Resistenza agli urti/Shock resistance

	IK00 Non protetto/ No protection	IK03 0,35 J	IK07 2,00 J
	IK01 0,15 J	IK04 0,50 J	IK08 5,00 J
	IK02 0,20 J	IK05 0,70 J	IK09 10,00 J
		IK06 1,00 J	IK10 20,00 J

Condizioni generali/General Conditions

Le potenze ed i flussi luminosi indicati nel presente catalogo sono riferiti alle sorgenti LED.

Wattage and lumens indicated in this catalogue are referred to the LED sources.

Lam32 srl si riserva il diritto di apportare modifiche ai prodotti della collezione al fine di miglioramento o per esigenze di carattere tecnico e commerciale. Vi invitiamo a consultare il sito www.lam32.com per avere i dati continuamente aggiornati.

Lam32 Ltd reserves the right to make every changes to the products of the this collection, to improve the betterment, or to meet the technical and commercial needs. We invite you to visit the website www.lam32.com for data updated.

