



design: R&D

TAPE

LAM32
IDEASBECOMINGLIGHT

Luminaire designed for wall, ceiling or floor installation. Suitable for high power LED sources. Its body is made of Anticorodal aluminium alloy, submitted to anodizing treatment up to 18 micron and polyester powder coated to ensure durability over time and maximum resistance against atmospheric agents. High quality PMMA optics with 180° light blade effect. The installation can be directly made on the surface, or through accessory plate that allow the leveling, thanks to the integrated spirit level and the rotation with mechanical lock. The protection degree IP66 is ensured by silicone gasket. It is equipped with a cable for connection to the power supply line with appropriate waterproof connection systems to be ordered separately. Integrated power supply.



TAPE



DISEGNO TECNICO/TECHNICAL DRAWING

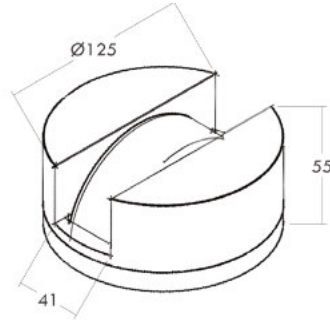

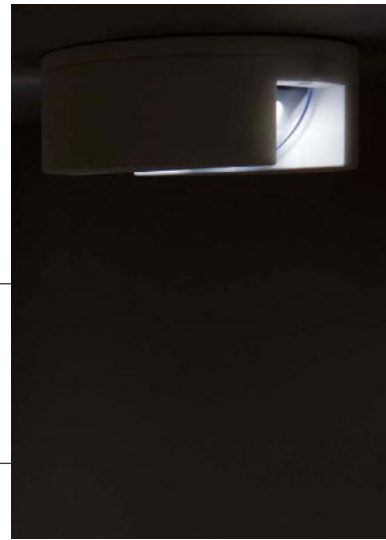

Ø125mm x H55mm



TAPE

codice/code	sorgente/lamp	lumen/lumens	
		3000K	4000K
02.102388	LED 3x2,2W	642	684

ACCESSORI/ACCESSORIES

codice/code	
	20.102389 Piastra girevole di 360° ed inclinabile di ± 20° dotata di scala graduata e livella di regolazione. / 360° Rotating plate and ± 20° tilting with extensional ladder and adjustment spirit level.
	20.104476 Accessorio anti abbagliamento / Anti-glare flaps



ESEMPIO COMPOSIZIONE CODICE / EXAMPLE OF CODE COMPOSITION

Alimentatore elettronico 220/240V 50-60Hz integrato nel corpo dell'apparecchio. / *Electronic driver 220/240V 50-60Hz integrated in the luminaire's body.*



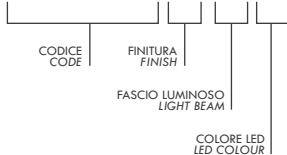

02.102388.01.EL.BF



Fascio luminoso/Light beam

.EL	lama di luce 180° / light blade 180°
Colore LED/LED Colour	
.BP	3000K
.BF	4000K

FINITURA/FINISH

colore/colour	codice/code	colore/colour	codice/code	colore/colour	codice/code
	.01 / verniciato bianco painted white		.02 / verniciato nero painted black		.03 / verniciato grigio painted grey
	.04 / verniciato cor-ten painted cor-ten		.11 / verniciato antracite painted anthracite		



LETTURA DEL CATALOGO READING THE CATALOGUE

**NOME FAMIGLIA
SERIES NAME**

FLAT EVO

DESIGN: R&D

**TIPI DI EMISSIONE LUMINOSA
TYPE OF LIGHT EMISSION**

**CONFIGURAZIONI DISPONIBILI
AVAILABLE CONFIGURATIONS**

**MARCHI E REQUISITI
MARKING AND REQUIREMENTS**

FLAT EVO 1		FLAT EVO 2	
codice/code	ottica/optic	sorgente/lamp	lumen/lumens
03.104050	.SP .MD .FL .RD	LED 1x2,2W	214 288
03.104051	.SP .MD .FL .RD	LED 4x2,2W	1020 1105

FLAT EVO 3		FLAT EVO 4	
codice/code	ottica/optic	sorgente/lamp	lumen/lumens
03.104053	.SP .MD .FL .RD	LED 8x2,2W	2040 2203
	.AS	LED 17,2W	2809 2896

Apparecchio realizzato in lega di alluminio Anticorrosal, per l'impiego continuo in ambito esterno, pensato per l'installazione a pavimento, parete e soffitto per mezzo di staffa orientabile in acciaio inox dotata di scala graduata e blocco meccanico del puntamento. Finalizzato all'impiego di sorgenti LED di alta potenza ha corpo sottoposto a trattamento di anodizzazione fino a 18 micron e verniciato a polveri di poliestere per garantire l'inalterabilità nel tempo e la massima resistenza agli attacchi di agenti atmosferici. Completa la struttura uno specifico schermo in vetro extrachiaro serigrafato e temprato, solidale al corpo mediante apposito collante sigillante di derivazione navale. Il grado di protezione dell'apparecchio IP66 è garantito dalla presenza di apposito sistema pressacavo stagno inserito nell'apparecchio. Ottiche di precisione in PMMA, consentono la propagazione del fascio luminoso a grandi distanze. La presenza di driver integrato ad ogni apparecchio permette la loro alimentazione a 230VAC. Dotato di 50cm di cavo in neoprene per il collegamento alla linea di alimentazione mediante appositi sistemi di giunzione da ordinare separatamente.

Luminaires made of anticorrosal alloy in outdoors area. It is designed for through stainless steel adjustable bracket and mechanical locking system, its body is submitted to anod and polyester powder coated to guarantee maximum resistance against atmospheric agents in tempered and screen-printed extrachiaro body through a special glue-sealer precision optics allow the propagation of light beam to long distances. The protection degree IP66 is ensured by system insert into the appliance. The supply at 230VAC. It is equipped for connection to the supply line, connection systems to be ordered separately.

**DESCRIZIONE TECNICA DELL'APPARECCHIO
LUMINAIRE TECHNICAL DESCRIPTION**

ESEMPIO COMPOSIZIONE CODICE / EXAMPLE OF CODE COMPOSITION

Alimentazione elettronic 220/240V 50-60Hz integrato nel corpo dell'apparecchio. / Electronic driver 220/240V 50-60Hz integrated in the luminaire's body.

03.104050.01.AS.BF

codice/code	FINITURA FINISH	FASCIO LUMINOSO LIGHT BEAM	COLORE LED/LED COLOUR
.SP	01 / verniciato bianco painted white	.SP fascio/beam 10°-15°	.SP 3000K
.MD	02 / verniciato nero painted black	.MD fascio/beam 20-35°	.MD 4000K
.FL	03 / verniciato grigio painted grey	.FL fascio/beam 40-55°	
.RD	04 / verniciato cor-ten painted cor-ten	.RD road	
.VE	05 / satinato satin	.VE vertical optical 8°x48°	
.HE	06 / lucido polished	.HE horizontal optical 48°x8°	

FINITURA FINISH		DESCRIZIONE SORGENTE LAMP DESCRIPTION	
colore/colour	codice/code	colore/colour	codice/code
White	01 / verniciato bianco painted white	Black	02 / verniciato nero painted black
Grey	03 / verniciato grigio painted grey	Grey	03 / verniciato grigio painted grey
Black	04 / verniciato cor-ten painted cor-ten	Black	04 / verniciato cor-ten painted black
Black	05 / satinato satin	Black	05 / satinato satin painted black
Black	06 / lucido polished	Black	06 / lucido polished painted black

**FINITURE DISPONIBILI
AVAILABLE FINISHES**

- .08/cemento
- .06/alluminio lucido o inox lucido
- .05/alluminio satinato o inox satinato
- .04/verniciato cor-ten
- .03 verniciato grigio (RAL 9006) o alluminio anodizzato
- .02/verniciato nero (RAL 9005) o anodizzato nero
- .01/verniciato bianco (RAL 9016)
- .00/naturale

DESCRIZIONE SORGENTE LAMP DESCRIPTION















OTTICHE OPTICS

DESCRIZIONE SORGENTE LAMP DESCRIPTION

**TABELLA COMPOSIZIONE CODICE
CODE COMPOSITION TABLE**

SIMBOLOGIA SYMBOLS

Configurazioni disponibili/Available configurations

	Apparecchio disponibile in versione RGB (solo per versioni con min. 3 lampade o versioni LED).	Luminaire available in RGB version (only for versions with a min. of 3 lamps or LED versions).
	Apparecchio disponibile in versione CTC (controllo temperatura di colore, solo per versioni con min. 3 lampade o versioni LED).	Luminaire available in CTC version (colour temperature control, only for versions with a min. of 3 lamps or LED versions).
	Apparecchio con possibilità di dimmerazione.	Luminaire has possibility to be dimmed.
	Apparecchio con possibilità di dimmerazione 0/10.	Luminaire has possibility to be dimmed 0/10.
	Apparecchio con possibilità di dimmerazione DALI.	Luminaire has possibility to be dimmed DALI.
	Apparecchio con possibilità di dimmerazione PWM.	Luminaire has possibility to be dimmed PWM.
	Apparecchio disponibile con apparato di diffusione sonora ad induzione.	Luminaire available with induction sound diffusion system.
	Apparecchio disponibile con Router Wi-Fi interno per la diffusione nello spazio circostante di segnali wire-less di ogni genere.	Luminaire available with internal Wi-Fi Router for the diffusion of any kind of wireless signal in the surrounding space.
	Kit emergenza	Emergency Kit
	Apparecchio personalizzabile (con fattibilità da verificare). Modifiche su richiesta: -finitura RAL -dimensione -tecnologia di comunicazione (DALI, WIFI o AUDIO integrato)	Luminaire customizable (with feasibility to be checked). Changes on request: -RAL finish -size -communication technology (integrated DALI, WIFI or AUDIO)
	Apparecchio disponibile a richiesta in versione RGB (solo per versioni con sorgente LED o con minimo 3 lampade).	Luminaire available, on request, in RGB version (only for LED versions or with a minimum of 3 lamps).
	Apparecchio disponibile a richiesta in versione CTC (controllo temperatura di colore, solo per versioni con min. 3 lampade o versioni LED).	Luminaire available, on request, in CTC version (colour temperature control, only for versions with a min. of 3 lamps or LED versions).
	Apparecchio disponibile su richiesta in versione dimmerabile.	Luminaire available, on request, in dimmable version.
	Apparecchio disponibile, su richiesta, con schermo microprismatizzato per elevato comfort visivo.	Luminaire available, on request, with microprismatic screen for high visual comfort.
	Protezione Acqua Stop	Water Stop protection

Protezioni IP/IP Protection degree code

1° CIFRA - Protezione da corpi solidi/

- IP1... Protezione da corpi solidi $\geq 50\text{mm}$
- IP2... Protezione da corpi solidi $\geq 12\text{mm}$
- IP3... Protezione da corpi solidi $\geq 2,5\text{mm}$
- IP4... Protezione da corpi solidi $\geq 1\text{mm}$
- IP5... Protezione da polvere
- IP6... Protezione totale da polvere

1st DIGIT - Protection against solid bodies

- IP1... Protection against solid bodies $\geq 50\text{mm}$
- IP2... Protection against solid bodies $\geq 12\text{mm}$
- IP3... Protection against solid bodies $\geq 2,5\text{mm}$
- IP4... Protection against solid bodies $\geq 1\text{mm}$
- IP5... Protection against dust
- IP6... Total protection against dust

2° CIFRA - Protezione da acqua

- IP..1 Protezione da caduta di gocce verticali
- IP..2 Protezione da caduta di gocce con inclinazione di 15°
- IP..3 Protezione da spruzzi d'acqua con inclinazione di 60° dall'alto
- IP..4 Protezione dagli spruzzi d'acqua da ogni direzione
- IP..5 Protezione dai getti d'acqua
- IP..6 Protezione da inondazioni
- IP..7 Protezione contro l'immersione temporanea fino a $30'$ sotto 1m d'acqua
- IP..8 Protezione contro l'immersione continua sotto 1m d'acqua













2nd DIGIT - Protection against water

- IP..1 Protection against vertically falling drops
- IP..2 Protection against vertically falling drops with a tilt angle up to 15°
- IP..3 Protection against sprays of water up to 60° from devertical
- IP..4 Protection against water spray from all directions
- IP..5 Protection against water jets
- IP..6 Protection against powerful water jets
- IP..7 Protection against temporary immersion up to $30'$ under 1m of water
- IP..8 Protection against continuous immersion under 1m of water

Tipologia di alimentazione/Power supply type



Marchi e requisiti/Certificates and requirements

	Apparecchio in classe prima con isolamento elettrico fondamentale. Deve essere collegato al circuito di terra dell'impianto elettrico generale.	Class I Luminaire with basic electrical insulation. It must be connected to the earth circuit of the general electrical system.
	Apparecchio in classe seconda con doppio isolamento elettrico. Non necessita di collegamento al circuito di terra dell'impianto elettrico.	Class II luminaire with double electrical insulation. There is no need for connection to the earth circuit of the electrical system.
	Apparecchio in classe terza predisposto per il collegamento a circuiti a bassissima tensione.	Class III luminaire suitable for connection to extra-low voltage circuits.
	Marchatura CE	CE Marking
	L'apparecchio può essere installato su superfici normalmente infiammabili.	The luminaire can be installed on normally flammable surfaces.
		
	ISO 9001	
	Ellissi di Macadam.	Macadam Ellipse.
	Resistenza al carico statico.	Static load resistance.
	Lunghezza del cavo di alimentazione in dotazione.	Length of supplied power cable.
	Uscita cavo di alimentazione L= Laterale P= Posteriore T= Testa	Cable Output L= Side P= Rear T= Head
	Protezione contro sbalzi di tensione	Protection against sudden changes in voltage.
	Protezione contro l'inversione di polarità	Reverse polarity protection.
	Rotazione dell'apparecchio sull'asse verticale.	Luminaire rotation on vertical axis.
	Inclinazione dell'apparecchio sull'asse orizzontale.	Luminaire inclination on horizontal axis.
	Tipo di emissione luminosa.	Type of light emission.

Resistenza agli urti/Shock resistance

	IK00 Non protetto/ No protection	IK03 0,35 J	IK07 2,00 J
	IK01 0,15 J	IK04 0,50 J	IK08 5,00 J
	IK02 0,20 J	IK05 0,70 J	IK09 10,00 J
		IK06 1,00 J	IK10 20,00 J

Condizioni generali/General Conditions

Le potenze ed i flussi luminosi indicati nel presente catalogo sono riferiti alle sorgenti LED.

Wattage and lumens indicated in this catalogue are referred to the LED sources.

Lam32 srl si riserva il diritto di apportare modifiche ai prodotti della collezione al fine di miglioramento o per esigenze di carattere tecnico e commerciale. Vi invitiamo a consultare il sito www.lam32.com per avere i dati continuamente aggiornati.

Lam32 Ltd reserves the right to make every changes to the products of the this collection, to improve the betterment, or to meet the technical and commercial needs. We invite you to visit the website www.lam32.com, as to have always the data updated.