



LAM32
IDEASBECOMINGLIGHT

ROUND EVO

Luminaire designed for floor, wall or ceiling installation through stainless steel adjustable supports and dedicated accessories. Suitable for high power LED sources. Its body is made of Anticorodal aluminium alloy, submitted to anodizing treatment and polyester powder coated to ensure durability over time and maximum resistance against atmospheric agents. A stainless steel support bracket and stainless steel screws allow its installation and orientation. Specific screens in extraclear screen-printed and tempered glass are integral to the body through a special glue-sealant used in shipbuilding. The protection degree IP66 is ensured by a special waterproof cable gland. High quality PMMA optics and black antiglare ring allow propagation of light for long distance. The integrated LED driver allows its power supply at 24VDC. The 230VAC versions are supplied by 0/10 power supplies. All products are equipped with a 50cm long neoprene cable for connection to the power supply line, through appropriate waterproof connection systems not included.



**LIGHTAT
MOTION**

LIGHT AT MOTION s.r.l. Via Risorgimento, 43 - 47869 Fratte Di Sassofeltrio (RN) - Italy
Tel. +39.0541. 51723 - www.lightatmotion.com - info@lightatmotion.com

info@fw-lighting.com

00 44 (0) 7891 919169



ROUND EVO

DISEGNO TECNICO/TECHNICAL DRAWING

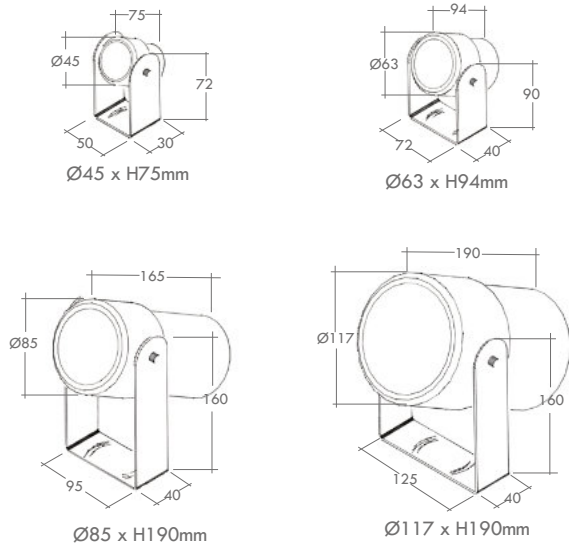

modello/ model	codice/code	sorgente/lamp	lumen/lumens		
			2700K	3000K	4000K
ROUND EVO 1 - 24VDC*	03.103807	LED 2,2W	203	214	228
ROUND EVO 2 - 24VDC*	03.103808	LED 6,3W	638	672	705
ROUND EVO 3 - 24VDC*	03.103809	LED 12W	1994	2066	2127
ROUND EVO 3 - 230VAC**	03.104184	LED 12W	1994	2066	2127
ROUND EVO 4 - 24VDC*	03.103810	LED 19W	2637	2802	2885
ROUND EVO 4 - 230VAC**	03.104185	LED 19W	2637	2802	2885

ESEMPIO COMPOSIZIONE CODICE / EXAMPLE OF CODE COMPOSITION

*Versione 24VDC/24VDC Version

Alimentatore elettronico 24VDC e sistemi di connessione da ordinare come accessori. Elettroniche di controllo: iSmart CV, iColor CV o iDimm CV, da ordinare come accessorio./

24VDC Electronic driver and connection systems to be ordered as accessories. Control Electronics: iSmart CV, iColor CV or iDimm CV, to be ordered as an accessory.

**Versione 230VAC/230VAC Version

Alimentatore elettronico 220/240V 0/10V 50-60Hz integrato nel corpo dell'apparecchio. Sistemi di connessione da ordinare come accessori.

Electronic driver 0/10V 220/240V 50-60Hz integrated in the luminaire's body. Connection systems to be ordered as accessories

*** Disponibile solo per Round Evo 1 / Available only for Round Evo 1

**** Disponibile solo per Round Evo 2 / Available only for Round Evo 2

***** Disponibile solo per Round Evo 1-3-4 / Available only for Round Evo 1-3-4

03.103807.01.SP.BF

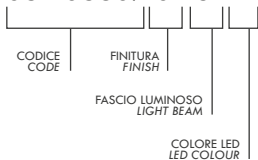

Fascio luminoso/Light beam

.SS***	fascio/beam 8°	
.SP	fascio/beam 12°	
.MD	fascio/beam 25°	
.FL****	fascio/beam 40°	
.HE****	horizontal elliptical	

Colore LED/LED Colour

.BC	2700K
.BP	3000K
.BF	4000K

03.104184.01.AN.SP.BF



Fascio luminoso/Light beam

.SP	fascio/beam 12°	
.MD	fascio/beam 25°	
.FL	fascio/beam 40°	

Colore LED/LED Colour

.BC	2700K
.BP	3000K
.BF	4000K

Tecnologia di comunicazione/Communication Technology

.AN	0/10V
.00	ON/OFF

FINITURA/FINISH

colore/colour	codice/code	colore/colour	codice/code	colore/colour	codice/code
	.01 / verniciato bianco painted white		.02 / verniciato nero painted black		.03 / alluminio anodizzato anodized aluminium
	.04 / verniciato cor-ten painted cor-ten		.11 / verniciato antracite painted anthracite		

ACCESSORI/ACCESSORIES

codice/code modello/version misure/sizes

Schermo 45°.		45° screen.	
	20.104161	ROUND EVO 2	Ø63xH70
	20.104162	ROUND EVO 3	Ø85xH95
	20.104163	ROUND EVO 4	Ø117xH125

Schermo cilindrico.		Cylindrical screen	
	20.104171	ROUND EVO 2	Ø85xH70
	20.104164	ROUND EVO 3	Ø85xH95
	20.104165	ROUND EVO 4	Ø117xH125

Porta accessori.		Accessory frame	
	20.104172	ROUND EVO 2	Ø63
	20.104166	ROUND EVO 3	Ø85
	20.104167	ROUND EVO 4	Ø117

Rifratore per distribuzione ellittica		Refractor for the elliptical distribution	
	20.104301	ROUND EVO 2	Ø63
	20.104302	ROUND EVO 3	Ø85
	20.104303	ROUND EVO 4	Ø117

Frangiluce nido d'ape		Honeycomb baffle	
	20.104173	ROUND EVO 2	Ø63
	20.104168	ROUND EVO 3	Ø85
	20.104169	ROUND EVO 4	Ø117

Griglia di protezione		Protection grid	
	20.104307	ROUND EVO 2	Ø63
	20.104308	ROUND EVO 3	Ø85
	20.104170	ROUND EVO 4	Ø117

Picchetto per installazione mobile a terreno.		Spike for furniture or ground installation.	
	20.104312	ROUND EVO 1	44xH286
	20.104312	ROUND EVO 2	44xH286
	20.104334	ROUND EVO 3	75xH400
	20.104334	ROUND EVO 4	75xH400

Fibbia per installazione mobile mediante apposite fasce e tenditori.		Clasp for furniture installation through appropriate bands and stretchers.	
	20.104318	ROUND EVO 1	70x50
	20.104318	ROUND EVO 2	70x50
	20.104332	ROUND EVO 3	100x50
	20.104332	ROUND EVO 4	100x50

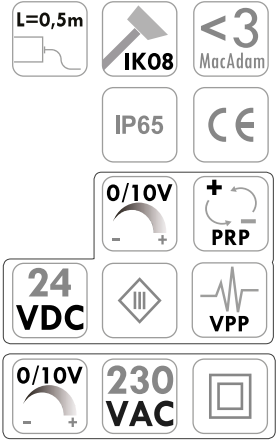

LETTURA DELLA SCHEDA READING THE DATA SHEET

NOME FAMIGLIA
SERIES NAME

MARCHI E REQUISITI
MARKING AND REQUIREMENTS

DISEGNO TECNICO
TECHNICAL DRAWING



BIN

DISEGNO TECNICO/TECHNICAL DRAWING

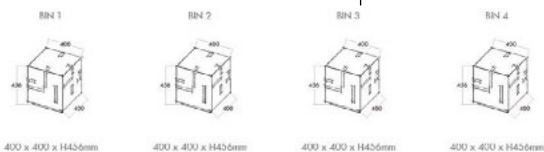

BIN LED	codice/code	sorgente/lamp	lumen/lumens
			3000K 4000K
BIN 1 LUCE/LIGHT	05.101.227	LED 20,5W	2237 2350
BIN 2 LUCE-AUDIO / LIGHT-AUDIO	05.101.238	LED 20,5W	2237 2350
BIN 3 LUCE-WIFI / LIGHT-WIFI	05.101.229	LED 20,5W	2237 2350
BIN 4 LUCE-AUDIO-WIFI / LIGHT-AUDIO-WIFI	05.101.230	LED 20,5W	2237 2350

FINITURA/FINISH

colore/colour	codice/code
	.05 / inox satinato swin stainless
	.04 / verniciato cor-ten painted cor-ten
	.03 / verniciato grigio painted grey
	.02 / verniciato nero painted black
	.01 / verniciato bianco painted white

ACCESSORI/ACCESSORIES

PIASTRA TIRAFONDI/ANCHOR PLATE	
codice/code	
	20.100379 520mm x 520mm H330mm

ESEMPIO COMPOSIZIONE CODICE / EXAMPLE OF CODE COMPOSITION

Alimentazione elettrica da 220/240V 50-60Hz integrato nel corpo dell'apparecchio. Fixation: da rete 220/240V 50-60Hz integrated in the luminaire's body.

05.101.227.01.BP		Codice LED/Led Code	
05	101	BP	3000K
227	01	TF	4000K

DESCRIZIONE TECNICA DELL'APPARECCHIO
LUMINAIRE TECHNICAL DESCRIPTION

Apparecchio pensato per l'installazione a pavimento finalizzato all'impiego di sorgenti LED. Corpo con base di fissaggio in lamiera di acciaio inox, piastra porta componenti interna in alluminio verniciato solidale alla base di fissaggio per mezzo di viti in acciaio inox. Completata la struttura una serie di schermi in PMMA opale solidati alla struttura per mezzo di appositi collanti sigillanti di derivazione aeronautica. Le versioni verniciate sono trattate con polveri di polibutene per garantire l'inerterabilità nel tempo e la massima resistenza agli attacchi degli agenti atmosferici. Tutte le componenti di questa serie possono essere realizzate anche in acciaio inox AISI 316L nelle finiture satinato, per lo quale viene applicato uno specifico anti-riflesso trattamento "Anti-Touch" che ne garantisce la pulizia nel tempo, o a richiesta lottino e specchio. L'installazione è consentita mediante l'impiego di viti per il fissaggio diretto al pavimento o mediante apposito piastra tirafondi in lamiera di acciaio inox con zanche di interramento per calcestruzzo. Il grado di protezione dell'apparecchio IP65 è garantito dall'apposito sistema pressostatico stagno e dai giunti di sigillatura. Il sistema alimentare elettronico integrato permette la sua alimentazione a tensione di rete.

Luminaire designed for floor installation, it of a body with fixing base in stainless steel in painted aluminium integral with the fix. The structure is completed by a series of PMMA integrated in the structure through appropriate. Painted versions are processed with polyn over film and maximum resistance against of this series can be also manufactured in 316L stainless steel, with satin finish, per "Anti-Touch" treatment to ensure electron luminaire's installation is allowed directly to appa. The protection degree IP65 is a glass system and silicon gaskets. The int voltage power supply.

DESCRIZIONE SORGENTE
LAMP DESCRIPTION

CODICE RADICE APPARECCHIO
LUMINAIRE CODE















.08/cemento	.08/concrete
.06/alluminio lucido o inox lucido	.06/polished aluminium or polished stainless
.05/alluminio satinato o inox satinato	.05/satin aluminium or satin stainless
.04/verniciato cor-ten	.04/painted cor-ten
.03/verniciato grigio (RAL 9006) o alluminio anodizzato	.03/painted grey (RAL 9006) or anodized aluminium
.02/verniciato nero (RAL 9005) o anodizzato nero	.02/painted black (RAL 9005) or black anodized
.01/verniciato bianco (RAL 9016)	.01/painted white (RAL 9016)
.00/naturale	.00/natural

FINITURE DISPONIBILI
AVAILABLE FINISHES

TABELLA COMPOSIZIONE CODICE
CODE COMPOSITION TABLE

SIMBOLOGIA SYMBOLS

Configurazioni disponibili/Available configurations

	Apparecchio disponibile in versione RGB (solo per versioni con min. 3 lampade o versioni LED).	<i>Luminaire available in RGB version (only for versions with a min. of 3 lamps or LED versions).</i>
	Apparecchio disponibile in versione CTC (controllo temperatura di colore, solo per versioni con min. 3 lampade o versioni LED).	<i>Luminaire available in CTC version (colour temperature control, only for versions with a min. of 3 lamps or LED versions).</i>
	Apparecchio con possibilità di dimmerazione.	<i>Luminaire has possibility to be dimmed.</i>
	Apparecchio con possibilità di dimmerazione 0/10.	<i>Luminaire has possibility to be dimmed 0/10.</i>
	Apparecchio con possibilità di dimmerazione DALI.	<i>Luminaire has possibility to be dimmed DALI.</i>
	Apparecchio con possibilità di dimmerazione PWM.	<i>Luminaire has possibility to be dimmed PWM.</i>
	Apparecchio disponibile con apparato di diffusione sonora ad induzione.	<i>Luminaire available with induction sound diffusion system.</i>
	Apparecchio disponibile con Router Wi-Fi interno per la diffusione nello spazio circostante di segnali wire-less di ogni genere.	<i>Luminaire available with internal Wi-Fi Router for the diffusion of any kind of wireless signal in the surrounding space.</i>
	Kit emergenza	<i>Emergency Kit</i>
	Apparecchio personalizzabile (con fattibilità da verificare). Modifiche su richiesta: -finitura RAL -dimensione -tecnologia di comunicazione (DALI,WIFI o AUDIO integrato)	<i>Luminaire customizable (with feasibility to be checked). Changes on request: -RAL finish -size -communication technology (integrated DALI,WIFI or AUDIO)</i>
	Apparecchio disponibile a richiesta in versione RGB (solo per versioni con sorgente LED o con minimo 3 lampade).	<i>Luminaire available, on request, in RGB version (only for LED versions or with a minimum of 3 lamps).</i>
	Apparecchio disponibile a richiesta in versione CTC (controllo temperatura di colore, solo per versioni con min. 3 lampade o versioni LED).	<i>Luminaire available, on request, in CTC version (colour temperature control, only for versions with a min. of 3 lamps or LED versions).</i>
	Apparecchio disponibile su richiesta in versione dimmerabile.	<i>Luminaire available, on request, in dimmable version.</i>
	Apparecchio disponibile, su richiesta, con schermo micropismatico per elevato comfort visivo.	<i>Luminaire available, on request, with micropismatic screen for high visual comfort.</i>
	Protezione Acqua Stop	<i>Water Stop protection</i>













Protezioni IP/IP Protection degree code

1° CIFRA - Protezione da corpi solidi/ IP1... Protezione da corpi solidi $\geq 50\text{mm}$ IP2... Protezione da corpi solidi $\geq 12\text{mm}$ IP3... Protezione da corpi solidi $\geq 2,5\text{mm}$ IP4... Protezione da corpi solidi $\geq 1\text{mm}$ IP5... Protezione da polvere IP6... Protezione totale da polvere	1st DIGIT – Protection against solid bodies IP1... Protection against solid bodies $\geq 50\text{mm}$ IP2... Protection against solid bodies $\geq 12\text{mm}$ IP3... Protection against solid bodies $\geq 2,5\text{mm}$ IP4... Protection against solid bodies $\geq 1\text{mm}$ IP5... Protection against dust IP6... Total protection against dust
2° CIFRA - Protezione da acqua IP...1 Protezione da caduta di gocce verticali IP...2 Protezione da caduta di gocce con inclinazione di 15° IP...3 Protezione da spruzzi d'acqua con inclinazione di 60° dall'alto IP...4 Protezione dagli spruzzi d'acqua da ogni direzione IP...5 Protezione dai getti d'acqua IP...6 Protezione da inondazioni IP...7 Protezione contro l'immersione temporanea fino a $30'$ sotto 1m d'acqua IP...8 Protezione contro l'immersione continua sotto 1m d'acqua	2nd DIGIT – Protection against water IP...1 Protection against vertically falling drops IP...2 Protection against vertically falling drops with a tilt angle up to 15° IP...3 Protection against sprays of water up to 60° from devertical IP...4 Protection against water spray from all directions IP...5 Protection against water jets IP...6 Protection against powerful water jets IP...7 Protection against temporary immersion up to $30'$ under 1m of water IP...8 Protection against continuous immersion under 1m of water

Tipologia di alimentazione/Power supply type



Marchi e requisiti/Certificates and requirements

	Apparecchio in classe prima con isolamento elettrico fondamentale. Deve essere collegato al circuito di terra dell'impianto elettrico generale.	<i>Class I Luminaire with basic electrical insulation. It must be connected to the earth circuit of the general electrical system.</i>
	Apparecchio in classe seconda con doppio isolamento elettrico. Non necessita di collegamento al circuito di terra dell'impianto elettrico.	<i>Class II luminaire with double electrical insulation. There is no need for connection to the earth circuit of the electrical system.</i>
	Apparecchio in classe terza predisposto per il collegamento a circuiti a bassissima tensione.	<i>Class III luminaire suitable for connection to extra-low voltage circuits.</i>
	Marchatura CE	<i>CE Marking</i>
	L'apparecchio può essere installato su superfici normalmente infiammabili.	<i>The luminaire can be installed on normally flammable surfaces.</i>
		
	Ellissi di MacAdam.	<i>Macadam Ellipse.</i>
	Resistenza al carico statico.	<i>Static load resistance.</i>
	Lunghezza del cavo di alimentazione in dotazione.	<i>Length of supplied power cable.</i>
	Uscita cavo di alimentazione L= Laterale P= Posteriore T= Testa	<i>Cable Output L= Side P= Rear T= Head</i>
	Protezione contro sbalzi di tensione	<i>Protection against sudden changes in voltage.</i>
	Protezione contro l'inversione di polarità	<i>Reverse polarity protection.</i>
	Rotazione dell'apparecchio sull'asse verticale.	<i>Luminaire rotation on vertical axis.</i>
	Inclinazione dell'apparecchio sull'asse orizzontale.	<i>Luminaire inclination on horizontal axis.</i>
	Tipo di emissione luminosa.	<i>Type of light emission.</i>

Resistenza agli urti/Shock resistance

	IK00 Non protetto/ No protection	IK03 0,35 J	IK07 2,00 J
	IK01 0,15 J	IK04 0,50 J	IK08 5,00 J
	IK02 0,20 J	IK05 0,70 J	IK09 10,00 J
		IK06 1,00 J	IK10 20,00 J

Condizioni generali/General Conditions

Le potenze ed i flussi luminosi indicati nel presente catalogo sono riferiti alle sorgenti LED.

Wattage and lumens indicated in this catalogue are referred to the LED sources.

Lam32 srl si riserva il diritto di apportare modifiche ai prodotti della collezione al fine di miglioramento o per esigenze di carattere tecnico e commerciale. Vi invitiamo a consultare il sito www.lam32.com per avere i dati continuamente aggiornati.

Lam32 Ltd reserves the right to make every changes to the products of the this collection, to improve the betterment, or to meet the technical and commercial needs. We invite you to visit the website www.lam32.com, as to have always the data updated.