



design: R&D

# NAIL PRO

**LAM32**  
IDEASBECOMINGLIGHT

Luminaire designed for recessed installation on walls, floors. Suitable for power LED sources for step-marker grazing light. Its body is made of Anticorodal aluminium submitted to anodizing treatment and AISI 316L stainless steel to guarantee durability over time and maximum resistance against atmospheric agents. The installation can be done under a pressure on a special casing in plastic material. The protection degree IP67 is ensured by a special waterproof cable gland system and silicone gaskets. The integrated LED driver allows its power at 24VDC. It is equipped with a 50cm long neoprene cable for connection to the power supply line, through appropriate waterproof connection systems not included. Remote power supply not included.



**LIGHTAT  
MOTION**

**LIGHT AT MOTION s.r.l.** Via Risorgimento, 43 - 47869 Fratte Di Sassofeltrio (RN) - Italy  
Tel. +39.0541. 51723 - [www.lightatmotion.com](http://www.lightatmotion.com) - [info@lightatmotion.com](mailto:info@lightatmotion.com)

[info@fw-lighting.com](mailto:info@fw-lighting.com)

00 44 (0) 7891 919169



# NAIL PRO

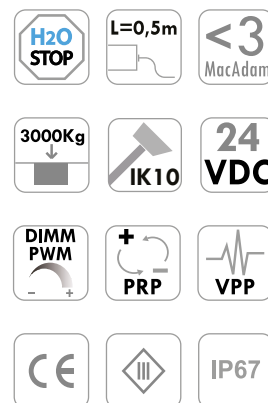

## DISEGNO TECNICO/TECHNICAL DRAWING

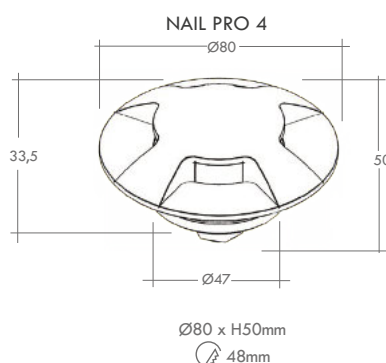
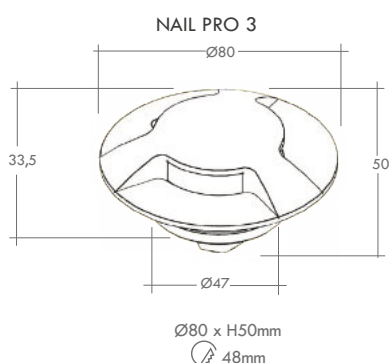
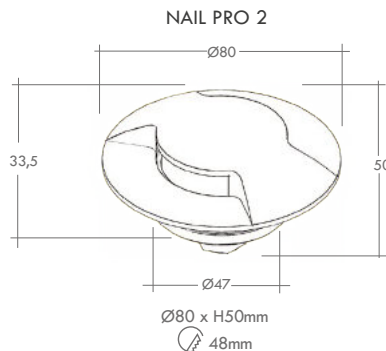
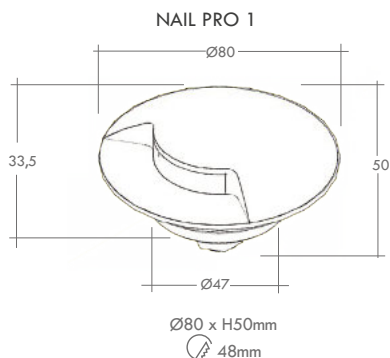

### NAIL PRO 1

codice/ code	misura/ size	sorgente/ lamp	lumen totali/ total lumens		
			2700K	3000K	4000K
07.104038	Ø80mm	LED 4W	440	475	510

### NAIL PRO 2

codice/ code	misura/ size	sorgente/ lamp	lumen totali/ total lumens		
			2700K	3000K	4000K
07.104039	Ø80mm	LED 4W	440	575	510

### NAIL PRO 3

codice/ code	misura/ size	sorgente/ lamp	lumen totali/ total lumens		
			2700K	3000K	4000K
07.104040	Ø80mm	LED 4W	440	575	510

### NAIL PRO 4

codice/ code	misura/ size	sorgente/ lamp	lumen totali/ total lumens		
			2700K	3000K	4000K
07.104041	Ø80mm	LED 4W	440	575	510

## ACCESSORI/ACCESSORIES

### codice/code



20.104145 Cassaforma/Case IP20  
Dimensioni/Sizes Ø90mm x H85mm  
Foro/Hole Ø48mm

## ESEMPIO COMPOSIZIONE CODICE / EXAMPLE OF CODE COMPOSITION

Alimentatore elettronico 24VDC e sistemi di connessione da ordinare come accessorio. Elettroniche di controllo: iSmart CV, iColor CV o iDimm CV, da ordinare come accessorio.

24VDC Electronic driver and connection systems to be ordered as an accessory. Control Electronics: iSmart CV, iColor CV or iDimm CV, to be ordered as an accessory.

07.104038.05.AS.BF

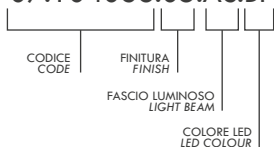

Fascio luminoso/Light beam	
.AS	asimmetrico/asymmetric
Colore LED/LED Colour	
.BC	2700K
.BP	3000K
.BF	4000K

## FINITURA/FINISH

colore/colour codice/code



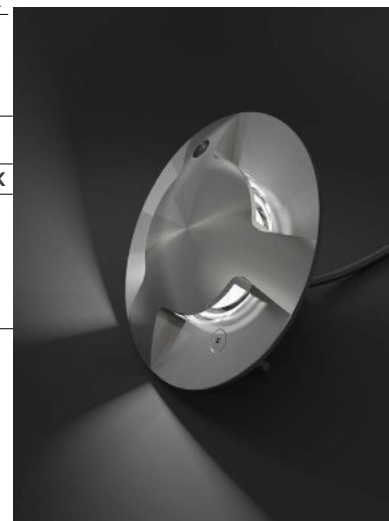
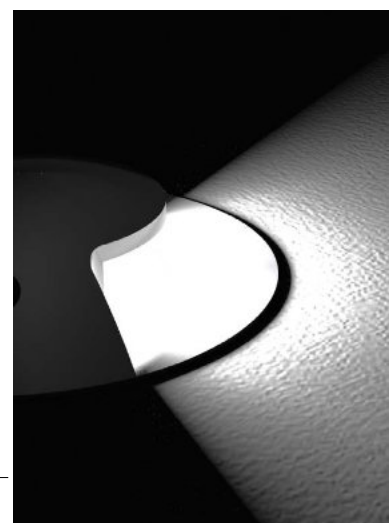











.05 / inox stainless





# SIMBOLOGIA SYMBOLS

## Configurazioni disponibili/Available configurations

	Apparecchio disponibile in versione RGB (solo per versioni con min. 3 lampade o versioni LED).	Luminaire available in RGB version (only for versions with a min. of 3 lamps or LED versions).
	Apparecchio disponibile in versione CTC (controllo temperatura di colore, solo per versioni con min. 3 lampade o versioni LED).	Luminaire available in CTC version (colour temperature control, only for versions with a min. of 3 lamps or LED versions).
	Apparecchio con possibilità di dimmerazione.	Luminaire has possibility to be dimmed.
	Apparecchio con possibilità di dimmerazione 0/10.	Luminaire has possibility to be dimmed 0/10.
	Apparecchio con possibilità di dimmerazione DALI.	Luminaire has possibility to be dimmed DALI.
	Apparecchio con possibilità di dimmerazione PWM.	Luminaire has possibility to be dimmed PWM.
	Apparecchio disponibile con apparato di diffusione sonora ad induzione.	Luminaire available with induction sound diffusion system.
	Apparecchio disponibile con Router Wi-Fi interno per la diffusione nello spazio circostante di segnali wire-less di ogni genere.	Luminaire available with internal Wi-Fi Router for the diffusion of any kind of wireless signal in the surrounding space.
	Kit emergenza	Emergency Kit
	Apparecchio personalizzabile (con fattibilità da verificare). Modifiche su richiesta: -finitura RAL -dimensione -tecnologia di comunicazione (DALI,WIFI o AUDIO integrato)	Luminaire customizable (with feasibility to be checked). Changes on request: -RAL finish -size -communication technology (integrated DALI,WIFI or AUDIO)
	Apparecchio disponibile a richiesta in versione RGB (solo per versioni con sorgente LED o con minimo 3 lampade).	Luminaire available, on request, in RGB version (only for LED versions or with a minimum of 3 lamps).
	Apparecchio disponibile a richiesta in versione CTC (controllo temperatura di colore, solo per versioni con min. 3 lampade o versioni LED).	Luminaire available, on request, in CTC version (colour temperature control, only for versions with a min. of 3 lamps or LED versions).
	Apparecchio disponibile su richiesta in versione dimmerabile.	Luminaire available, on request, in dimmable version.
	Apparecchio disponibile, su richiesta, con schermo microprismatizzato per elevato comfort visivo.	Luminaire available, on request, with microprismatic screen for high visual comfort.
	Protezione Acqua Stop	Water Stop protection

## Protezioni IP/IP Protection degree code

### 1° CIFRA - Protezione da corpi solidi/

IP1...	Protezione da corpi solidi $\geq 50\text{mm}$
IP2...	Protezione da corpi solidi $\geq 12\text{mm}$
IP3...	Protezione da corpi solidi $\geq 2,5\text{mm}$
IP4...	Protezione da corpi solidi $\geq 1\text{mm}$
IP5...	Protezione da polvere
IP6...	Protezione totale da polvere

### 1st DIGIT - Protection against solid bodies

IP1...	Protection against solid bodies $\geq 50\text{mm}$
IP2...	Protection against solid bodies $\geq 12\text{mm}$
IP3...	Protection against solid bodies $\geq 2,5\text{mm}$
IP4...	Protection against solid bodies $\geq 1\text{mm}$
IP5...	Protection against dust
IP6...	Total protection against dust

### 2° CIFRA - Protezione da acqua

IP..1	Protezione da caduta di gocce verticali
IP..2	Protezione da caduta di gocce con inclinazione di $15^\circ$
IP..3	Protezione da spruzzi d'acqua con inclinazione di $60^\circ$ dall'alto
IP..4	Protezione dagli spruzzi d'acqua da ogni direzione
IP..5	Protezione dai getti d'acqua
IP..6	Protezione da inondazioni
IP..7	Protezione contro l'immersione temporanea fino a $30'$ sotto $1\text{m}$ d'acqua
IP..8	Protezione contro l'immersione continua sotto $1\text{m}$ d'acqua











### 2nd DIGIT - Protection against water

IP..1	Protection against vertically falling drops
IP..2	Protection against vertically falling drops with a tilt angle up to $15^\circ$
IP..3	Protection against sprays of water up to $60^\circ$ from devertical
IP..4	Protection against water spray from all directions
IP..5	Protection against water jets
IP..6	Protection against powerful water jets
IP..7	Protection against temporary immersion up to $30'$ under $1\text{m}$ of water
IP..8	Protection against continuous immersion under $1\text{m}$ of water

## Tipologia di alimentazione/Power supply type



## Marchi e requisiti/Certificates and requirements

	Apparecchio in classe prima con isolamento elettrico fondamentale. Deve essere collegato al circuito di terra dell'impianto elettrico generale.	Class I Luminaire with basic electrical insulation. It must be connected to the earth circuit of the general electrical system.
	Apparecchio in classe seconda con doppio isolamento elettrico. Non necessita di collegamento al circuito di terra dell'impianto elettrico.	Class II luminaire with double electrical insulation. There is no need for connection to the earth circuit of the electrical system.
	Apparecchio in classe terza predisposto per il collegamento a circuiti a bassissima tensione.	Class III luminaire suitable for connection to extra-low voltage circuits.
	Marchatura CE	CE Marking
	L'apparecchio può essere installato su superfici normalmente infiammabili.	The luminaire can be installed on normally flammable surfaces.
		
	Ellissi di Macadam.	Macadam Ellipse.
	Resistenza al carico statico.	Static load resistance.
	Lunghezza del cavo di alimentazione in dotazione.	Length of supplied power cable.
	Uscita cavo di alimentazione L= Laterale P= Posteriore T= Testa	Cable Output L= Side P= Rear T= Head
	Protezione contro sbalzi di tensione	Protection against sudden changes in voltage.
	Protezione contro l'inversione di polarità	Reverse polarity protection.
	Rotazione dell'apparecchio sull'asse verticale.	Luminaire rotation on vertical axis.
	Inclinazione dell'apparecchio sull'asse orizzontale.	Luminaire inclination on horizontal axis.
	Tipo di emissione luminosa.	Type of light emission.

## Resistenza agli urti/Shock resistance

	IK00 Non protetto/ No protection	IK03 0,35 J	IK07 2,00 J
	IK01 0,15 J	IK04 0,50 J	IK08 5,00 J
	IK02 0,20 J	IK05 0,70 J	IK09 10,00 J
		IK06 1,00 J	IK10 20,00 J

## Condizioni generali/General Conditions

Le potenze ed i flussi luminosi indicati nel presente catalogo sono riferiti alle sorgenti LED.

Wattage and lumens indicated in this catalogue are referred to the LED sources.

Lam32 srl si riserva il diritto di apportare modifiche ai prodotti della collezione al fine di miglioramento o per esigenze di carattere tecnico e commerciale. Vi invitiamo a consultare il sito [www.lam32.com](http://www.lam32.com) per avere i dati continuamente aggiornati.

Lam32 Ltd reserves the right to make every changes to the products of the this collection, to improve the betterment, or to meet the technical and commercial needs. We invite you to visit the website [www.lam32.com](http://www.lam32.com), as to have always the data updated.