



design: R&D

**A3 - 65**  
**A3 - E**

**LAM32**  
IDEASBECOMINGLIGHT

The smoothing and painting system is designed for recessed flush installation on plasterboard ceilings and walls edges. Luminaire designed for recessed installation on false ceilings using appropriate accessories. Suitable for LED sources of different powers, their body is made of anodized extruded aluminium, full filled with a special opal resin, resistant to UV rays, to ensure the maximum level of performance, visual comfort and cleanness over time. Closing end caps are made of anodized aluminium. The luminaires are supplied with rear cable output. It is equipped with a 50cm long cable for connection to the 24VDC power supply line. 24VDC Electronic driver to be ordered as an accessory.



# A3 - 65

## DISEGNO TECNICO/TECHNICAL DRAWING

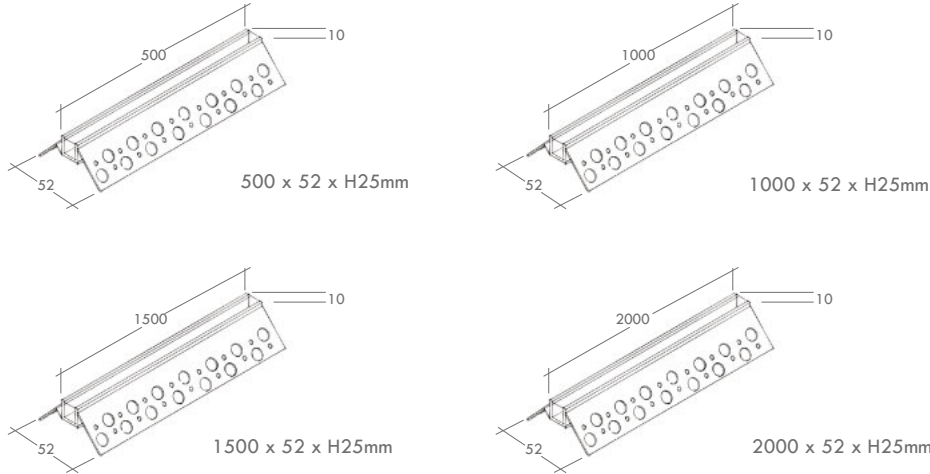

nome/name	misure/dimension	codice/code	sorgente/lamp	lumen/lumens		
				2700K	3000K	4000K
A3-65	500	04.104559	LED 5,4W	787	830	856
A3-65	1000	04.104560	LED 10,8W	1575	1660	1712
A3-65	1500	04.104561	LED 16,2W	2362	2490	2568
A3-65	2000	04.104562	LED 21,6W	3150	3320	3424

## ACCESSORI/ACCESSORIES

### codice/code



20.104567 Tappo di chiusura / Closing end cap

## ESEMPIO COMPOSIZIONE CODICE/ EXAMPLE OF CODE COMPOSITION

Alimentatore elettronico 24VDC e sistemi di connessione da ordinare come accessorio. *Electronic driver and connection systems 24VDC to be ordered as an accessory. Control Electronics, iSmart CV, iColor CV o iDimm CV, da ordinare come accessorio. *Electronics di controllo, iSmart CV, iColor CV o iDimm CV, to be ordered as accessory.**

04.104559.03.DI.BP.P

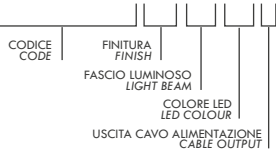

## FINITURA/FINISH

colore/colour	codice/code
	.03 / alluminio anodizzato anodized aluminium

## Fascio luminoso / Light beam

.DI diffuso / diffused			
codice/code	Colore LED / LED Colour	potenza/m / power/m	lumen/m / lumens/m
.BC	2700K	10,8W	1575
.BP	3000K	10,8W	1660
.BF	4000K	10,8W	1712

## Uscita cavo / Cable exit

.P	posteriore/rear
----	-----------------



# A3 - E



## DISEGNO TECNICO/TECHNICAL DRAWING

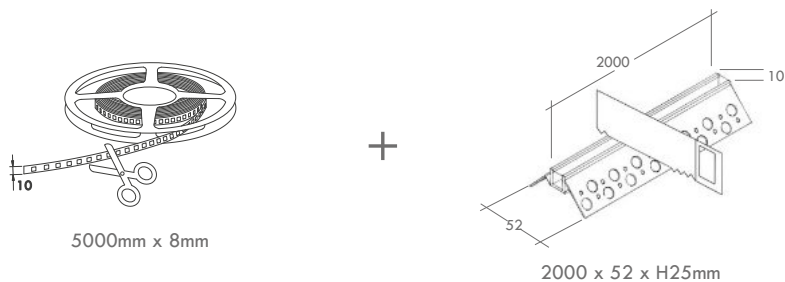

nome/name	misure/dimension	codice/code	grado IP	sorgente/lamp	lumen/lumens		
					2700K	3000K	4000K
CIRCUITO LED IN BOBINE/ LED CIRCUIT REEL	5000	30.104543	IP20	10,8 W/m	1575	1660	1712
A3 - E	2000	30.104564	IP40				

## ACCESSORI/ACCESSORIES

codice/code	
	20.104567 Tappo di chiusura / Closing end cap

## ESEMPIO COMPOSIZIONE CODICE CIRCUITO LED/ EXAMPLE OF CODE COMPOSITION LED CIRCUIT

Alimentatore elettronico 24VDC e sistemi di connessione da ordinare come accessorio. Control Electronics, iSmart CV, iColor CV or iDimm CV, da ordinare come accessorio.

*Electronic driver and connection systems 24VDC to be ordered as an accessory. Control Electronics, iSmart CV, iColor CV or iDimm CV, to be ordered as accessory.*

**30.104543.DP.BP.20**

CODICE CODE | FASCIO LUMINOSO LIGHT BEAM | COLORE LED LED COLOUR | POTENZA AL METRO POWER PER METRE

Fascio luminoso/Light beam				
Led	Colore/Colour	lm/m	Led/m	Taglio/Cut
.DP	diffuso perpendicolare/perpendicular diffused			
.BC	2700K	1575	160	50mm
.BP	3000K	1660	160	50mm
.BF	4000K	1712	160	50mm
Potenza circuito Led/Led circuit power				
.10			10,8W/m	

## FINITURA/FINISH

colore/colour	codice/code
	.03 / alluminio anodizzato anodized aluminium

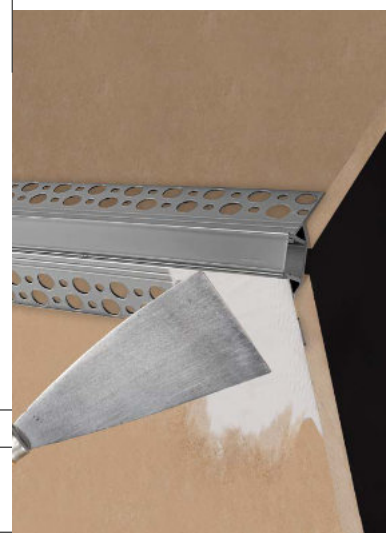

# LETTURA DELLA SCHEDA READING THE DATA SHEET

NOME FAMIGLIA  
SERIES NAME

MARCHI E REQUISITI  
MARKING AND REQUIREMENTS

DISEGNO TECNICO  
TECHNICAL DRAWING



design FABIO ROTILIA  
**BIN**

Apparecchio pensato per l'installazione a pavimento finalizzato all'impiego di sorgenti LED. Corpo con base di fissaggio in lamiera di acciaio inox, piastra porta componenti interna in alluminio verniciato solidale alla base di fissaggio per mezzo di viti in acciaio inox. Completata la struttura una serie di schermi in PMMA opale solidati alla struttura per mezzo di appositi collanti sigillanti di derivazione aeronautica. Le versioni verniciate sono trattate con polveri di polibutene per garantire l'inalterabilità nel tempo e la massima resistenza agli attacchi degli agenti atmosferici. Tutte le componenti di questa serie possono essere realizzate anche in acciaio inox AISI 316L nelle finiture satinato, per lo quale viene applicato uno specifico anti-riflesso trattamento "Anti-Touch" che ne garantisce la pulizia nel tempo, o a richiesta lottino e specchio. L'installazione è consentita mediante l'impiego di viti per il fissaggio diretto a pavimento o mediante apposito piastra tirafondi in lamiera di acciaio inox con zanche di interramento per calcestruzzo. Il grado di protezione dell'apparecchio IP65 è garantito dall'apposito sistema pressostatico stagno e dai guarnizioni siliconiche. Il sistema alimentatore elettronico integrato permette la sua alimentazione a tensione di rete.

Luminaire designed for floor installation, it of a body with fixing base in stainless steel in painted aluminium integral with the fixing plate. The structure is completed by a series of PMMA integrated in the structure through appropriate adhesive sealants of aeronautical derivation. Painted versions are processed with polybutene powder and maximum resistance against of this series can be also manufactured in 316L stainless steel, with satin finish, for "Anti-Touch" treatment to ensure cleanliness in time, or on request matt and mirror. The installation is allowed directly by means of screws for the direct fastening to the floor or by means of an anchor plate in stainless steel with earthing brackets for concrete. The protection degree IP65 is guaranteed by the specific pressostatic system and the silicon gaskets. The integrated power supply.

## BIN

DISEGNO TECNICO/TECHNICAL DRAWING

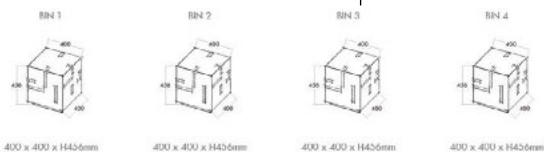

	codice/code	sorgente/lamp	lumen/lumens
			3000K 4000K
BIN 1 LUCE/LIGHT	05.101.227	LED 20,5W	2237 2350
BIN 2 LUCE-AUDIO / LIGHT-AUDIO	05.101.238	LED 20,5W	2237 2350
BIN 3 LUCE-WIFI / LIGHT-WIFI	05.101.229	LED 20,5W	2237 2350
BIN 4 LUCE-AUDIO-WIFI / LIGHT-AUDIO-WIFI	05.101.230	LED 20,5W	2237 2350

FINITURA/FINISH

colore/colour	codice/code
	05 / inox satinato
	04 / verniciato cor-ten
	03 / verniciato grigio
	02 / verniciato nero
	01 / verniciato bianco

ACCESSORI/ACCESSORIES

PIASTRA TIRAFONDI/ANCHOR PLATE	
codice/code	
	20.100379 520mm x 520mm H330mm

ESEMPIO COMPOSIZIONE CODICE / EXAMPLE OF CODE COMPOSITION

Alimentazione elettronica 220/240V 50-60Hz integrato nel corpo dell'apparecchio. / Electronic driver 220/240V 50-60Hz integrated in the luminaire's body.

05.101.227.01.BP		Codice LED/LED Code	
05	101	BP	3000K
227	01	TP	4000K

DESCRIZIONE TECNICA DELL'APPARECCHIO  
LUMINAIRE TECHNICAL DESCRIPTION

.08/cemento	.08/concrete
.06/alluminio lucido o inox lucido	.06/polished aluminium or polished stainless
.05/alluminio satinato o inox satinato	.05/satin aluminium or satin stainless
.04/verniciato cor-ten	.04/painted cor-ten
.03/verniciato grigio (RAL 9006) o alluminio anodizzato	.03/painted grey (RAL 9006) or anodized aluminium
.02/verniciato nero (RAL 9005) o anodizzato nero	.02/painted black (RAL 9005) or black anodized
.01/verniciato bianco (RAL 9016)	.01/painted white (RAL 9016)
.00/naturale	.00/natural

FINITURE DISPONIBILI  
AVAILABLE FINISHES















TABELLA COMPOSIZIONE CODICE  
CODE COMPOSITION TABLE

DESCRIZIONE SORGENTE  
LAMP DESCRIPTION

CODICE RADICE APPARECCHIO  
LUMINAIRE CODE

# SIMBOLOGIA SYMBOLS

## Configurazioni disponibili/Available configurations

	Apparecchio disponibile in versione RGB (solo per versioni con min. 3 lampade o versioni LED).	Luminaire available in RGB version (only for versions with a min. of 3 lamps or LED versions).
	Apparecchio disponibile in versione CTC (controllo temperatura di colore, solo per versioni con min. 3 lampade o versioni LED).	Luminaire available in CTC version (colour temperature control, only for versions with a min. of 3 lamps or LED versions).
	Apparecchio con possibilità di dimmerazione.	Luminaire has possibility to be dimmed.
	Apparecchio con possibilità di dimmerazione 0/10.	Luminaire has possibility to be dimmed 0/10.
	Apparecchio con possibilità di dimmerazione DALI.	Luminaire has possibility to be dimmed DALI.
	Apparecchio con possibilità di dimmerazione PWM.	Luminaire has possibility to be dimmed PWM.
	Apparecchio disponibile con apparato di diffusione sonora ad induzione.	Luminaire available with induction sound diffusion system.
	Apparecchio disponibile con Router Wi-Fi interno per la diffusione nello spazio circostante di segnali wire-less di ogni genere.	Luminaire available with internal Wi-Fi Router for the diffusion of any kind of wireless signal in the surrounding space.
	Kit emergenza	Emergency Kit
	Apparecchio personalizzabile (con fattibilità da verificare). Modifiche su richiesta: -finitura RAL -dimensione -tecnologia di comunicazione (DALI, WIFI o AUDIO integrato)	Luminaire customizable (with feasibility to be checked). Changes on request: -RAL finish -size -communication technology (integrated DALI, WIFI or AUDIO)
	Apparecchio disponibile a richiesta in versione RGB (solo per versioni con sorgente LED o con minimo 3 lampade).	Luminaire available, on request, in RGB version (only for LED versions or with a minimum of 3 lamps).
	Apparecchio disponibile a richiesta in versione CTC (controllo temperatura di colore, solo per versioni con min. 3 lampade o versioni LED).	Luminaire available, on request, in CTC version (colour temperature control, only for versions with a min. of 3 lamps or LED versions).
	Apparecchio disponibile su richiesta in versione dimmerabile.	Luminaire available, on request, in dimmable version.
	Apparecchio disponibile, su richiesta, con schermo microprismatizzato per elevato comfort visivo.	Luminaire available, on request, with microprismatic screen for high visual comfort.
	Protezione Acqua Stop	Water Stop protection

## Protezioni IP/IP Protection degree code

### 1° CIFRA - Protezione da corpi solidi/

- IP1... Protezione da corpi solidi  $\geq 50\text{mm}$
- IP2... Protezione da corpi solidi  $\geq 12\text{mm}$
- IP3... Protezione da corpi solidi  $\geq 2,5\text{mm}$
- IP4... Protezione da corpi solidi  $\geq 1\text{mm}$
- IP5... Protezione da polvere
- IP6... Protezione totale da polvere

### 1st DIGIT - Protection against solid bodies

- IP1... Protection against solid bodies  $\geq 50\text{mm}$
- IP2... Protection against solid bodies  $\geq 12\text{mm}$
- IP3... Protection against solid bodies  $\geq 2,5\text{mm}$
- IP4... Protection against solid bodies  $\geq 1\text{mm}$
- IP5... Protection against dust
- IP6... Total protection against dust

### 2° CIFRA - Protezione da acqua

- IP...1 Protezione da caduta di gocce verticali
- IP...2 Protezione da caduta di gocce con inclinazione di  $15^\circ$
- IP...3 Protezione da spruzzi d'acqua con inclinazione di  $60^\circ$  dall'alto
- IP...4 Protezione dagli spruzzi d'acqua da ogni direzione
- IP...5 Protezione dai getti d'acqua
- IP...6 Protezione da inondazioni
- IP...7 Protezione contro l'immersione temporanea fino a  $30'$  sotto  $1\text{m}$  d'acqua
- IP...8 Protezione contro l'immersione continua sotto  $1\text{m}$  d'acqua















### 2nd DIGIT - Protection against water

- IP...1 Protection against vertically falling drops
- IP...2 Protection against vertically falling drops with a tilt angle up to  $15^\circ$
- IP...3 Protection against sprays of water up to  $60^\circ$  from devertical
- IP...4 Protection against water spray from all directions
- IP...5 Protection against water jets
- IP...6 Protection against powerful water jets
- IP...7 Protection against temporary immersion up to  $30'$  under  $1\text{m}$  of water
- IP...8 Protection against continuous immersion under  $1\text{m}$  of water

## Tipologia di alimentazione/Power supply type



## Marchi e requisiti/Certificates and requirements

	Apparecchio in classe prima con isolamento elettrico fondamentale. Deve essere collegato al circuito di terra dell'impianto elettrico generale.	Class I Luminaire with basic electrical insulation. It must be connected to the earth circuit of the general electrical system.
	Apparecchio in classe seconda con doppio isolamento elettrico. Non necessita di collegamento al circuito di terra dell'impianto elettrico.	Class II luminaire with double electrical insulation. There is no need for connection to the earth circuit of the electrical system.
	Apparecchio in classe terza predisposto per il collegamento a circuiti a bassissima tensione.	Class III luminaire suitable for connection to extra-low voltage circuits.
	Marchatura CE	CE Marking
	L'apparecchio può essere installato su superfici normalmente infiammabili.	The luminaire can be installed on normally flammable surfaces.
	ESQ ISO 9001	
	Ellissi di Macadam.	Macadam Ellipse.
	Resistenza al carico statico.	Static load resistance.
	Lunghezza del cavo di alimentazione in dotazione.	Length of supplied power cable.
	Uscita cavo di alimentazione L= Laterale P= Posteriore T= Testa	Cable Output L= Side P= Rear T= Head
	Protezione contro sbalzi di tensione	Protection against sudden changes in voltage.
	Protezione contro l'inversione di polarità	Reverse polarity protection.
	Rotazione dell'apparecchio sull'asse verticale.	Luminaire rotation on vertical axis.
	Inclinazione dell'apparecchio sull'asse orizzontale.	Luminaire inclination on horizontal axis.
	Tipo di emissione luminosa.	Type of light emission.

## Resistenza agli urti/Shock resistance

	IK00 Non protetto/ No protection	IK03 0,35 J	IK07 2,00 J
	IK01 0,15 J	IK04 0,50 J	IK08 5,00 J
	IK02 0,20 J	IK05 0,70 J	IK09 10,00 J
		IK06 1,00 J	IK10 20,00 J

## Condizioni generali/General Conditions

Le potenze ed i flussi luminosi indicati nel presente catalogo sono riferiti alle sorgenti LED.

Wattage and lumens indicated in this catalogue are referred to the LED sources.

Lam32 srl si riserva il diritto di apportare modifiche ai prodotti della collezione al fine di miglioramento o per esigenze di carattere tecnico e commerciale. Vi invitiamo a consultare il sito [www.lam32.com](http://www.lam32.com) per avere i dati continuamente aggiornati.

Lam32 Ltd reserves the right to make every changes to the products of the this collection, to improve the betterment, or to meet the technical and commercial needs. We invite you to visit the website [www.lam32.com](http://www.lam32.com), as to have always the data updated.